

How to Choose the Right Mineral Wool for Insulation



3

How to Choose the Right Mineral Wool for Insulation

20

The Manufacturing Process of ROCKWOOL Stone Wool

4

Fire Safety and Resistance to High Temperatures

22

Application of ROCKWOOL Stone Wool Products

10

Usage and Maintenance of the Buildings

12

Efficiencies and Cost Savings

13

Mechanical Properties of Mineral Wool

15

Designed Occupancy Comfort Level

18

Green Product and Sustainability

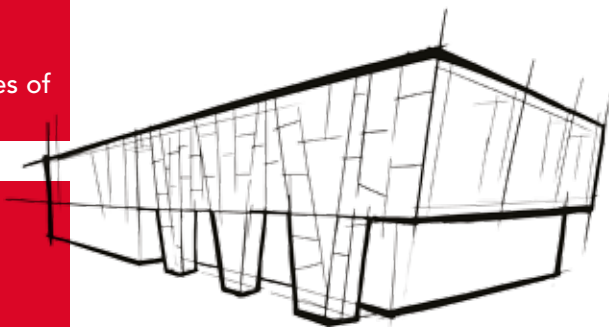

How to choose the right mineral wool for insulation

Mineral wool is commonly used as an insulation material in buildings and built structures. There are different types of mineral wool, produced from a variety of production methods and technologies and are generally available in a wide variety of forms.

A key consideration for designers, consultants, builders and building owners when choosing the right type of mineral wool insulation is to ensure that it meets their requirements on application and design parameters. Based on industry practices and contemporary building design that focuses on values and benefits mineral wool is used within building elements to perform and complement these conditions:

- Fire safety and resistance to high temperatures
- Usage and maintenance of the buildings
- Efficiencies and cost savings
- Designed occupancy comfort level
- Green product and sustainability

The samples that were studied in this document draw references to commonly available mineral wool and its applications within buildings, tabulated in the table below.

| ROCKWOOL stone wool | |
|-------------------------------|--|
| 40-60kg/m ³ | Drywall partition and single skin roof |
| 60kg/m ³ and above | Double skin roof |

| Generic stone wool | |
|------------------------|--------------------------------|
| 10-24kg/m ³ | Single skin & double skin roof |
| 16-32kg/m ³ | Drywall partition |

Note: All stone wool samples used in the studies are ROCKWOOL insulation products; therefore stone wool in this document only refers to ROCKWOOL stone wool products.



Elaborations and data shown in this document are based on third party laboratory and ROCKWOOL internal tests where empirical estimation and calculations are made. The main objective of these studies is to provide specifiers and building stakeholders with key insights on the important criteria that need to be considered when selecting mineral wool for construction.

ROCKWOOL Asia would like to address that generic glass wool products appear to be subject to variances in performance and appearance according to manufacturers. It is recommended that further testing and detailed analysis be conducted for specific products if needed. Please contact ROCKWOOL Asia for further information.

Fire Safety and Resistance to High Temperatures

Can mineral wool reduce fire risk?

Common regulations in fire safety specify that building spaces be categorised into minimum periods of fire resistance that are dependent on the size and usage of the building. As the risk of fire hazards increase, so too does the need for building elements with better fire safety performance. Therefore, the materials used within a building element play an important role in reducing the spread and growth of a fire.

As such, building elements such as walls, floors and other separating elements are designed to be in accordance to fire compartmentation requirements, which require such elements to be able to provide fire resistance in terms of:

- Integrity
- Insulation
- Load bearing

Building elements such as walls and partitions are designed according to requirements of 1-hour, 2-hours, and up to 4-hours fire resistance in most building designs.

Fire resistance refers to the ability of a building elements to resist the spread of fire for a specific period of time, thus preventing the fire from spreading from one space to another. Typically, building elements such as partitions and ceiling systems are installed with mineral wool materials as part of a system that contributes to achieving such performance requirements.

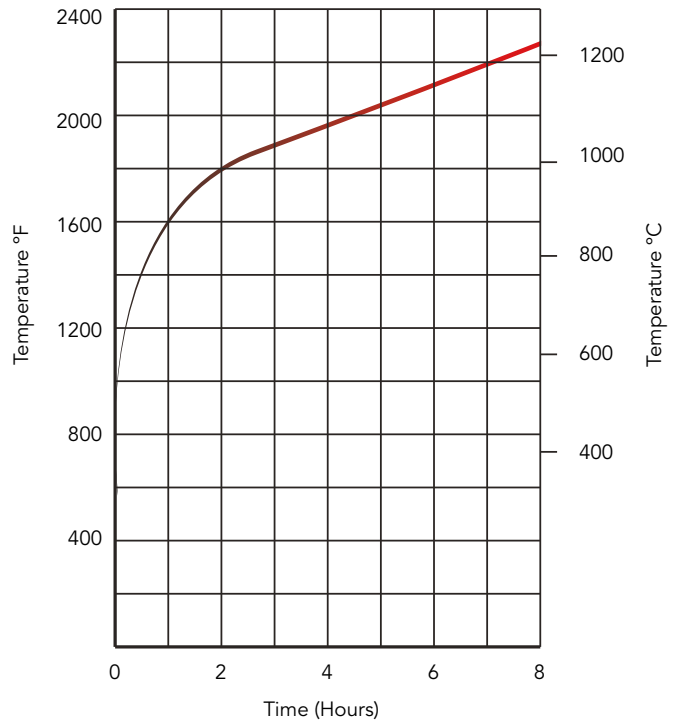

The following are the points that determine the curve.

| | |
|-----------------|-----------------|
| 1000°F / 538°C | 5 minutes |
| 1300°F / 704°C | 10 minutes |
| 1550°F / 843°C | 30 minutes |
| 1700°F / 927°C | 1 hour |
| 1850°F / 1010°C | 2 hours |
| 2000°F / 1093°C | 4 hours |
| 2300°F / 1260°C | 8 hours or over |

It is important that mineral wool, when used as an insulation material, is able to withstand high temperatures without losing its properties and integrity.

To achieve that, the mineral wool must first have a high melting point in order to meet such requirements. Relevant tests conducted establish that ROCKWOOL stone wool possesses a high melting point compared to the other types of mineral wools such as generic glass wool. The table below shows the comparisons of the respective melting point according to density.

The melting point of mineral wool is a critical attribute when used in building elements such as drywall partitions and roofing systems - aside from fire resistance, better tolerances against high temperatures translate to longer effective lifespans, as well as to provide better insulation against heat. These factors add value beyond the fire resistance performance of the building element.

To further illustrate the reaction of mineral wool in fire conditions, an over-heating test (sintering) was conducted to identify the changes in different types of mineral wool under incremental temperatures, volumetric changes and other qualitative observations.



| Type of Mineral Wool | Density | Heating Rate | Melting Point (ASTM E794-06) |
|----------------------|---------------------|------------------|------------------------------|
| ROCKWOOL stone wool | 40kg/m ³ | 20°C (50-1280°C) | 1218°C* |
| Generic glass wool | 16kg/m ³ | 10°C (50-1200°C) | 651°C* |
| Generic glass wool | 32kg/m ³ | 10°C (50-1200°C) | 648°C* |

* Test report available upon request

Oven-Heating Test (Sintering)

Tests are conducted on ROCKWOOL stone wool and generic glass wool, where the samples are inserted into a furnace at increasing temperatures at specific intervals, ranging from an initial temperature of 250°C, up to 1000°C.

| Type of Mineral Wool | Density |
|----------------------|---|
| ROCKWOOL stone wool | 40kg/m ³ |
| Generic glass wool | 10kg/m ³ , 16kg/m ³ , 32kg/m ³ |

Observation

Samples are prepared in the size of 50mm X 50mm X 75mm.

| Observation Samples at room temperature |  | | | |
|---|--|---|---|---|
| | ROCKWOOL stone wool (40kg/m ³) | Generic glass wool (10kg/m ³) | Generic glass wool (16kg/m ³) | Generic glass wool (32kg/m ³) |
| Observation | In full form and thickness | In full form and thickness | In full form and thickness | In full form and thickness |

| Observation at oven temperature 350°C |  | | | |
|---------------------------------------|--|--|---|---|
| | ROCKWOOL stone wool (40kg/m ³) | Generic glass wool (10kg/m ³) | Generic glass wool (16kg/m ³) | Generic glass wool (32kg/m ³) |
| Observation | Surface appear to be slightly darker | Surface appear to be slightly darker/ dark brown in colour | Surface appear to be darker/dark grey in colour | |
| Volumetric Change | Nil | Nil | Nil | Nil |

How to Choose the Right Mineral Wool for Insulation

| Observation at oven temperature 650°C |  | | | |
|---------------------------------------|--|--|------------------------------|------------------------------|
| | ROCKWOOL stone wool (40kg/m³) | Generic glass wool (10kg/m³) | Generic glass wool (16kg/m³) | Generic glass wool (32kg/m³) |
| Observation | Surface appears to change to a pale yellowish brown | Surface appears to change to a pale white in colour and further appears to have shrunk in size | | |
| Volumetric Change | +10% | -50% | -58% | -45% |

| Observation at oven temperature 850°C |  | | | |
|---------------------------------------|--|--|------------------------------|------------------------------|
| | ROCKWOOL stone wool (40kg/m³) | Generic glass wool (10kg/m³) | Generic glass wool (16kg/m³) | Generic glass wool (32kg/m³) |
| Observation | Surface appears to change to a pale yellowish brown | Article appears to have significantly shrunk in size, become solid marble-like substance | | |
| Volumetric Change | -27% | -99% | -97% | -97% |

How to Choose the Right Mineral Wool for Insulation

From the tests conducted it is clearly noticeable that glass wool, which is typically made from molten glass, is not able to withstand high temperatures. When exposed to temperatures beyond 650°C, it appears that glass wool shrinks tremendously, and when the temperature increases to 850°C, it appears to lose its integrity completely and shrinks to an almost insignificant size.

From the results of the tests conducted, the resulting physical change in the glass wool shows that glass wool does not contribute in providing extra protection to building elements such as roofing systems, drywall partitions and ceilings. The typical temperatures reached in a fire can quickly surpass the melting point of glass wool, and the test results suggested it may shrink and collapse within the installation itself, leaving its previously occupied space avoid.

ROCKWOOL stone wool on the other hand is able to withstand temperatures up to 1000°C, and only reaches its melting point at about 1260°C. It also features a unique inbuilt cohesiveness and layering of the fibres that keep the overall structure intact, maintaining its rigidity and protecting the material from being affected at high temperatures. These attributes help ROCKWOOL stone wool to effectively contribute towards the fire resistance of a building element, and to provide better insulation against heat passing through it. This brings about extra benefits to the building element in multiple folds.

ROCKWOOL stone wool also passes the following tests that relate to the performance of insulation material to the reaction of fire namely non-combustibility, no flame spread and no toxic smoke development.

| Test Standard | Description |
|------------------|---|
| BS 476 Part 4* | Fire Tests on Building Materials and Structures - Non-combustibility test for materials |
| BS 476 Part 6* | Fire Tests on Building Materials and Structures - Method of test for fire propagation for products |
| BS 476 Part 7* | Fire Tests on Building Materials and Structures - Method of test to determine the classification of the surface spread of flame of products |
| EN 13501 Part 1* | Fire Classification of Construction Products and Building Elements - Classification using data from reaction to fire tests |

*Test reports available upon request



Usage and Maintenance of the Buildings

Benefits of mineral wool insulation with low water absorption

The tropical climate and unique lifestyles in Asia exposes buildings to a high amount of moisture and humidity, either directly from weather, or from the usage of the building, such as cleaning and condensation from differential surface temperatures from one space to another.

This creates a concern regarding the resistance of building materials such as mineral wool to be able to resist moisture and humidity. This important criterion is measured through the water absorption rate in accordance to EN1609, and results are shown below.

| Mineral Wool Type | Water Absorption Rate (EN1609) |
|--|--|
| ROCKWOOL stone wool 40kg/m ³ | *0.12kg/ m ³ |
| Generic glass wool 16kg/m ³ | Excessive water absorption. Test aborted* |
| Generic glass wool 32kg/m ³ | Excessive water absorption. Test aborted* |

*Test reports available upon request

The water absorption rate of ROCKWOOL stone wool is 0.12kg/m³ by volume of moisture, whereas the water absorption tests for generic glass wool were unable to be carried out due to the excessive water absorption even at the initial partial immersion procedure.

It is important for mineral wool to have a low water absorption rate, to ensure that it does not contain excessive moisture or water that may cause risks and /or damage to the building.

For example, when building elements such as the roof system suffers from a leakage, the insulation material in the roof system will be directly exposed to water. If the mineral wool used has a high water absorption rate, it may cause fasteners, fixtures or the metal structure of the roofing system to corrode over time due to excessive exposure to moisture. This can then lead to high repair and maintenance costs. What makes such situations worse is that leaking roof systems often remain unnoticed, and over time, the roof system may even be at risk of collapse due to the corrosion damage. Therefore it is important that the insulation material used do not absorb water, and be able to repel water from the roof effectively to ensure a robust, safe structure.



Additionally, building elements such as partition walls and roof structures are always exposed to interstitial condensation due to differential surface temperatures from one space to another. Differential surface temperatures occur when warm and moist air from one side of a building element meets with a colder surface through convection and conduction. Hence, it is crucial that the mineral wool used in building elements not only not absorbs water, but also not retain moisture if interstitial condensation occurs.

In this regard, ROCKWOOL stone wool is specially produced with a water repellency feature - making it 'breathable', therefore increasing water vapour performance for faster drying. This also allows ROCKWOOL stone wool to restore to its original state of insulation value, which meant that when it is completely dried, the product would still be usable and unlikely to need replacing. Additionally, as ROCKWOOL stone wool is made from inorganic materials it does not promote rot, corrosion, fungi or mould growth.

On the other hand, through studies, glass wool appears to absorb high amount of water, which brings about the following risks:

- 1 Absorbed high water content will decrease the performance in thermal resistance, hence becoming less effective in thermal insulation.
- 2 May caused corrosion to the fasteners and fixtures of a building system such as roofs.
- 3 If contaminated with organic material, fungi and mould will grow, staining building elements such as partition boards, and eventually cause high repair costs.
- 4 May become unstable due to its weight and its porosity makes it slump in the cavity of the building element like drywall and roof system, losing the major part of the thermal insulation performance.



Generic glass wool 16kg/m³



Generic glass wool 32kg/m³

Efficiencies and Cost Savings

How does using the right mineral wool insulation save cost?

An effective insulation material is one that is able to achieve its intended performance criteria, such as thermal insulation, making the investment spent in installing it worthwhile. In order to achieve the best efficiencies and value for money, one important criterion that the design need to look into first is the mechanical properties of the mineral wool. The mechanical properties include compression strength and dimensional stability.

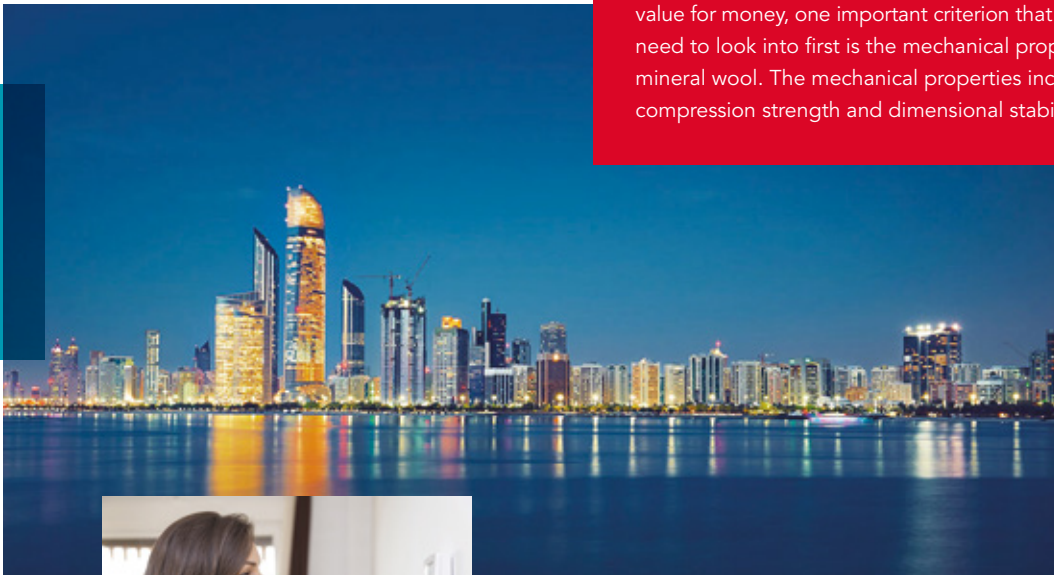

Mechanical Properties of Mineral Wool

Dimensional stability

ROCKWOOL stone wool is an effective insulation material with better resistance to compression compared to generic glass wool. This is due to the unique structure of the ROCKWOOL stone wool fibres, which are fixed in horizontal and vertical directions, making it a non-directional structure overall.

Generic glass wool, which typically has low densities, may be more susceptible to slump down on itself over time due to gravitational forces. Such poor dimensional stability may lead to the occurrence of lower thermal performances of the building system. Essentially, the effectiveness of an insulation depends on the compression strength and dimensional stability of the material used, in order to perform as designed or at its optimum level.



Fibre structure of ROCKWOOL stone wool



Fibre structure of glass wool

Thermal insulation parameters

The term dimensional stability is generally defined as the material's ability to retain its original shape when subjected to external forces such as varying degrees of temperatures, atmospheric pressures, moisture content and/or other external stresses. In order to express the importance of thermal insulation performances, the key parameters such as the thermal conductivity, λ -value or k-value, thermal resistance, R-value and thermal transmittance, U-value are defined as below

Thermal Conductivity, λ -value or k-value is given by a number indicating how well a substance conducts heat. It indicates the quantity of heat in terms of W.h which is conducted through 1 m² of the material with a thickness of 1 m in the course of one hour, the difference in temperature between the two surface being 1°C. It is said that the lower the λ -value is, the higher its insulation value.

Thermal resistance, R-value is the heat property and a measurement of a temperature difference by which an object or material resists a heat flow (heat per time unit). Thermal resistance is the reciprocal of thermal conductivity multiplied by the thickness of the material. Thermal resistivity is the reciprocal of thermal conductivity and can be expressed as

$R = 1/k \times t$, where

R = thermal resistance (m²°C / W, hr ft²°F/Btu)

k = thermal conductivity (W/m²°C, Btu in/hr ft²°F)

t = thickness of material (m)

Thermal Transmittance, U-value is the insulation ability of a structure, generally expressed as the amount of heat in terms of W.h, transmitted through 1 m² of construction in the course of 1 hour, when the difference in temperatures between outside and inside is 1°C. This means that the lower the U-value is, the better the construction insulates.

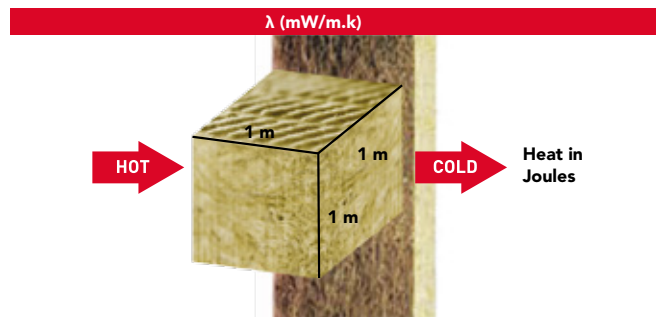

The thermal properties of ROCKWOOL stone wool is tabulated as below:

| Nominal Density | Slab | Blanket |
|----------------------|------------------|------------------|
| | K-value* (W/m.K) | K-value* (W/m.K) |
| 40kg/m ³ | 0.035 | 0.035 |
| 50kg/m ³ | - | 0.035 |
| 60kg/m ³ | 0.034 | 0.034 |
| 80kg/m ³ | 0.034 | 0.034 |
| 100kg/m ³ | 0.034 | 0.034 |
| 120kg/m ³ | 0.034 | - |
| 140kg/m ³ | 0.034 | - |

*Test reports available

Based on the thermal resistance above, the effect of thermal insulation is directly related to the effective thickness of the insulation material. The designed thickness of insulation material must be maintained throughout the lifetime of the building element, so that the intended designed performances in thermal insulation can be achieved. In other words, the occupants' indoor comfort level while using the space under such thermal insulation performance is related to the effective thickness of the insulation material.

The first principle in product selection is that the delivered thickness should be the same as per what was specified within the acceptable limits of tolerances. The most common issues pertaining to the thickness revolves round two factors, which are the packaging of the mineral wool and the recovery rate of the thickness of the mineral wool if they were compressed for logistic purposes.

Regardless of the types packaging, whether compressed or delivered in actual thickness; the thickness of the mineral wool should be stable and consistent throughout its application such as when used in roof insulation. This includes having the mineral wool to recover to its intended thickness at the point of installation and to maintain its physical integrity throughout the lifetime of the building element.

Therefore, apart from the criteria of thermal conductivity in the selection of mineral wool, it is also equally important for the mineral wool to have dimensional stability in order to ensure optimum thermal performance is achieved. When installed in a roofing system, ROCKWOOL stone wool appeared stable and rigid and able to maintain its physical characteristics throughout the lifetime of the building. The product did not expand or contract from the ambience temperature variances, nor was it affected by the presence of moisture. ROCKWOOL stone wool has good dimensional stability thus reducing the risk of slumping, sagging or warping. This is essential for long term performance and durability of the insulation in a building.

ROCKWOOL stone wool also has low thermal conductivity in accordance to ASTM C518, making it a very effective choice of insulation material used in building elements. It has been tested and shown to be an excellent insulator and a vital component to help reduce energy used for cooling of buildings under tropical climates, therefore also contributing towards savings in electricity costs.



Designed Occupancy Comfort Level









Does using the right mineral wool insulation effect my comfort?

Another important criterion in deciding which insulation material to use is in regards to the designed occupancy comfort level. Thermal and acoustic performance of building elements are crucial in achieving the desired levels of indoor comfort for occupants.

Mineral wool is normally used as infill in various building elements such as partitions, wall coverings/linings, ceilings and roofing systems to provide sound absorption properties and to increase the sound isolation of the building element, making the indoor environment more quiet and comfortable for home and workplaces.

Acoustic control and noise reduction using mineral wool improves the quality of the environment in schools, offices, public institutions and industrial premises. Installing ROCKWOOL stone wool provides a significant and tangible reduction of external noise from traffic or adjacent spaces, such as noise coming from nearby floors and rooms.



| dB | Results of noise level |
|-----|---|
| 140 |  Hearing impairment of adult (peak noise) |
| 120 |  Hearing impairment of child (peak noise) |
| 100 |  Hearing impairment (daily noise for 1 hour) |
| 80 |  Hearing impairment (daily noise for 24 hours) |
| 60 |  Serious annoyance (outdoor) |
| 40 |  Disturbance of communication |
| 20 |  Sleep disturbance |
| 0 |  |

Noise Reduction Coefficient (NRC) is a scalar representation of the amount of sound energy absorbed upon striking a particular surface. NRC value of 0 indicates perfect reflection whereas NRC 1.0 indicates perfect absorption of sound energy.

For example, 50mm thick ROCKWOOL stone wool is capable of improving the acoustic performance of a building element up to STC 8.

ROCKWOOL stone wool provides excellent sound absorption properties, with a sound absorption property of NRC 1.0 at a thickness of 50 mm when tested under the standard BS EN ISO 354:2003. When used as wall coverings or linings in surface sound absorption, ROCKWOOL stone wool provides surface sound

absorption, ROCKWOOL stone wool provides better speech intelligibility within indoor noise levels, allowing for clearer communication, and better work concentration levels. ROCKWOOL stone wool's unique non-directional fibre structure with air-filled interconnected voids make it a material with good noise absorbing qualities.

Although both ROCKWOOL stone wool and generic glass wool provide sound absorption properties, ROCKWOOL stone wool is complemented with technical services and advices from our dedicated team, such as consideration of ambient noise levels on top of the performance on sound isolation properties of individual building elements.





Holbrook House, Little Waldingfield,
Sudbury, Suffolk CO10 0TF
Tel: (01787) 247595
e-mail: srl@srtsl.com



Contract: C/21751

Page: 1 of 1

Date: 21 May 2015

Confidential

See SRL report C/21751/T01 for full details

The Laboratory Measurement of Random Incidence Sound Absorption to BS EN ISO 354:2003

Client: Rockwool Asia
Test Date: 21/09/2011
Empty Room: Temperature: 17.8 °C Humidity: 68 %RH Pressure: 1010 mbar
Room with Sample: Temperature: 17.8 °C Humidity: 69 %RH Pressure: 1010 mbar
Sample Description: Safe 'n' Silent Pro370, 1200x600x50mm 80kg/m³
Mounting Method: A
Sample Area: 10.8 m²
Chamber Volume: 300 m³

Test 19

| Freq Hz | T1 sec | T2 sec | Absorp Coeff | Practical Absorp Coeff # |
|---------|--------|--------|--------------|--------------------------|
| 50* | 4.45 | 4.29 | 0.04 | |
| 63* | 4.73 | 4.47 | 0.06 | n/a |
| 80* | 5.76 | 5.17 | 0.09 | |
| 100 | 7.97 | 6.92 | 0.09 | |
| 125 | 8.21 | 5.94 | 0.21 | 0.20 |
| 160 | 7.93 | 4.92 | 0.35 | |
| 200 | 7.61 | 4.02 | 0.53 | |
| 250 | 7.95 | 3.37 | 0.77 | 0.75 |
| 315 | 7.72 | 3.01 | 0.91 | |
| 400 | 6.86 | 2.57 | 1.09 | |
| 500 | 5.66 | 2.36 | 1.11 | 1.00 |
| 630 | 5.22 | 2.15 | 1.23 | |
| 800 | 5.69 | 2.35 | 1.12 | |
| 1000 | 6.33 | 2.41 | 1.15 | 1.00 |
| 1250 | 6.14 | 2.45 | 1.10 | |
| 1600 | 5.60 | 2.36 | 1.10 | |
| 2000 | 5.18 | 2.28 | 1.10 | 1.00 |
| 2500 | 4.63 | 2.13 | 1.14 | |
| 3150 | 3.93 | 2.01 | 1.10 | |
| 4000 | 3.30 | 1.83 | 1.10 | 1.00 |
| 5000 | 2.64 | 1.61 | 1.10 | |
| 6300* | 2.01 | 1.38 | 1.04 | |
| 8000* | 1.71 | 1.20 | 1.15 | n/a |
| 10000* | 1.18 | 0.90 | 1.23 | |

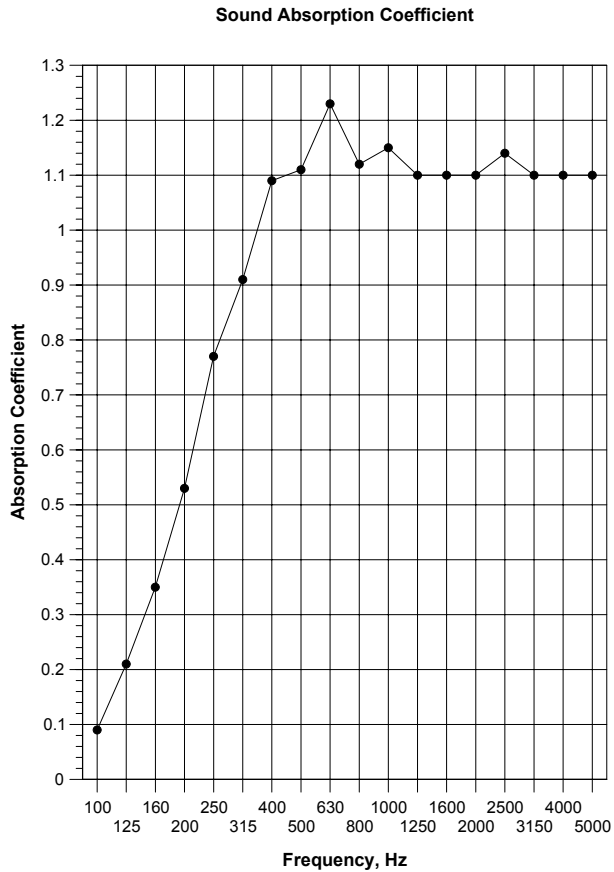

α_w 1.00
Class A
 Calculated to EN ISO 11654:1997
NRC 1.05
 Calculated to ASTM C 423-01
 * Denotes frequencies outside the range covered by BS EN ISO 354:2003
 T1, empty room reverberation time
 T2, room reverberation time with sample

Practical absorption coefficient, BS EN ISO 11654:1997

v3.2

Laboratory Engineer

Quality Manager

Green Product and Sustainability

Is mineral wool insulation environmental friendly?

It is also equally important that mineral wool insulation, when used as part of the building element, does not negatively impact the environment or its surroundings. The solution should be a green product – one that does not cause any harm to occupants and to the environment. Made from igneous stone, Basalt, ROCKWOOL stone wool is recyclable and also contains recycled content (both pre-consumer and post-consumer recycled content, up to 12%).

The unique combination of properties in ROCKWOOL stone wool makes it a very versatile and attractive insulation solution for buildings. It is designed to be more durable, sustainable, fire resistant, dense, and water resistant than other insulation materials. This makes it a sustainable, long-term energy efficient solution for many exterior and interior applications.

Results

| Sample | Test Result (After 24 hours) | Criteria for Singapore Green Label Product | Inferred Result |
|------------------------------------|--------------------------------------|--|-----------------|
| "Thermalrock® B40" Product Samples | 0.006 mg per m ³ per hour | 0.25mg per m ³ per hour or less | Pass |

Table 1. Total Volatile Organic Compounds (TVOC) Emission Rate Test Result

| Sample | Test Result (After 24 hours) | Criteria for Singapore Green Label Product | Inferred Result |
|------------------------------------|--------------------------------------|--|-----------------|
| "Thermalrock® B40" Product Samples | <0.02 mg per m ³ per hour | 0.02mg per m ³ per hour or less | Pass |

Table 2. Formaldehyde Emission Rate Test Result

| Sample | Test Result (After 24 hours) | Criteria for Singapore Green Label Product | Inferred Result |
|------------------------------------|------------------------------|--|-----------------|
| "Thermalrock® B40" Product Samples | Not Detected* | 0.0065mg per m ³ per hour or less | Pass |

Table 3. 4-Phenylcyclohexene Emission Rate Test Result

| Sample | Test Result (After 24 hours) | Criteria for Singapore Green Label Product | Inferred Result |
|------------------------------------|------------------------------|--|-----------------|
| "Thermalrock® B40" Product Samples | <0.003 mg per m ³ | <0.01mg per m ³ | Pass |

Table 4. Total Phthalate Emission Test Result

| Sample | Test Result (After 24 hours) | Criteria for Singapore Green Label Product | Inferred Result |
|------------------------------------|------------------------------|--|-----------------|
| "Thermalrock® B40" Product Samples | <0.02 mg per m ³ | <0.02mg per m ³ | Pass |

Table 5. Total Particles Emission Test Result

Based on ASTM D5116 emission rate tests, ROCKWOOL stone wool passes all criteria as required by the standard, with the results shown below. It is not asbestos, nor does not contain any asbestos either. Additionally, the low volatile organic content (VOC) and low formaldehyde further makes it a better choice for insulation, as it does not emit harmful substances to the environment that can potentially affect the health of a building's occupants.

| Type of insulation | SGBC Green Building Product Labelling Scheme - Rating |
|---------------------|---|
| ROCKWOOL stone wool | ✓✓✓ Achieved up to 3 ticks |

ROCKWOOL stone wool is listed under the Green Label of the Singapore Green Building Council (SGBC), and when used in green building design such as Green Mark in Singapore or Green Building Index (GBI) in Malaysia, it contributes to several scoring criteria as below:

1. Energy Efficiency of Building Envelope
2. Indoor Air Quality
3. Regional Material



The Manufacturing Process of ROCKWOOL Stone Wool

The manufacturing of ROCKWOOL stone wool uses natural and inorganic stone to create natural fibres without the use of blowing agents. This results in stone wool that inherits the special traits of stones, combined with the characteristics of typical wool insulation.

The typical production process for ROCKWOOL stone wool begins with the fusion of volcanic stone at a temperature of 1500°C. Basalt, dolomite and coke are automatically fed from the top of a cupola furnace. The melt runs out of the bottom of the furnace and onto a machine, where wool is literally spun.

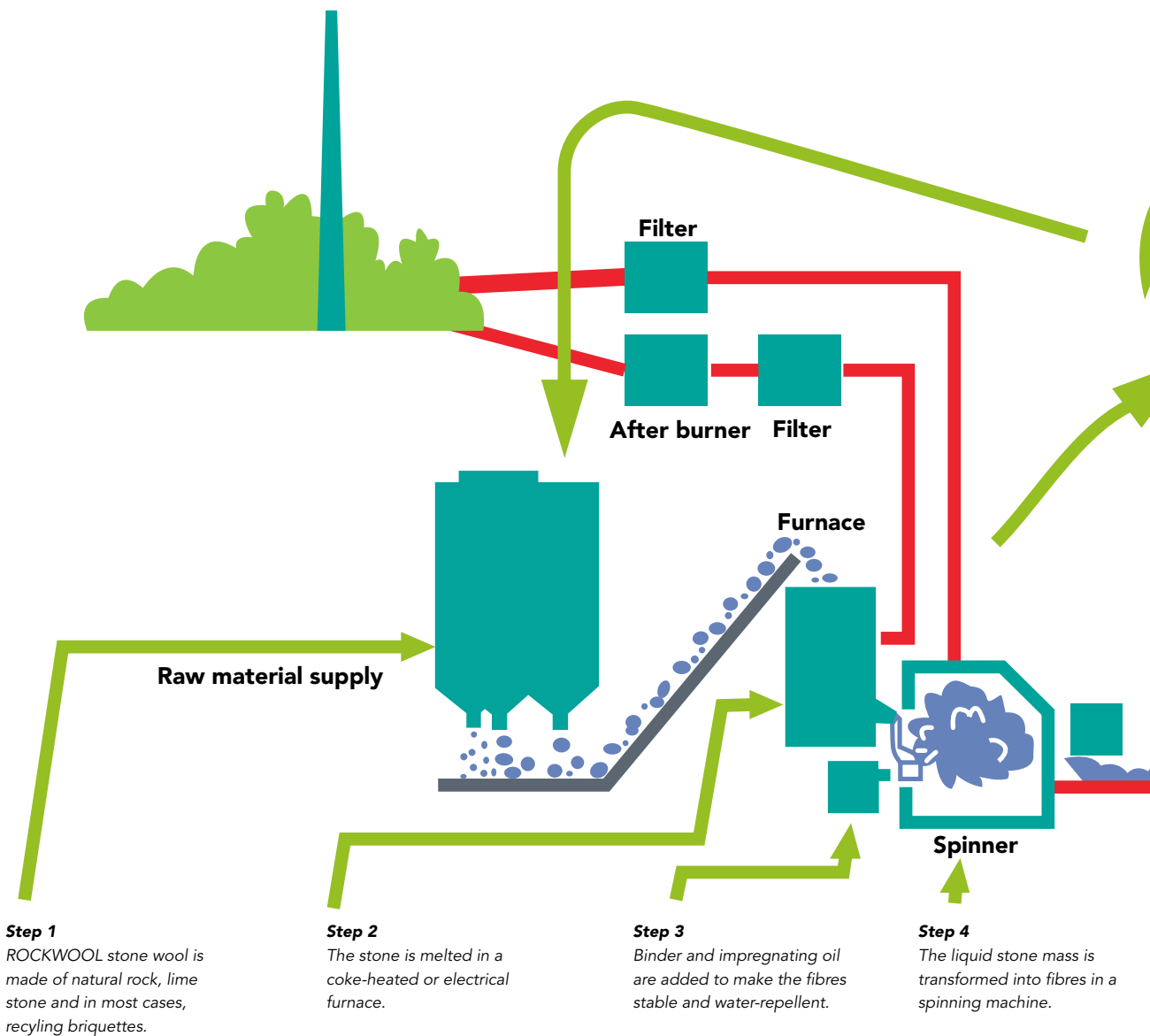

Small amounts of organic binder and oil are then added, and the wool is collected on a belt conveyor in a collection chamber. The structure and density of the wool are adjusted on a forming table that helps determine its final use according to types of product. It then moves to a curing oven where the final properties of the product are maintained after the curing process.

The product will then undergo cutting and packaging processes, as well as any off-line value added treatment and processes. The wastes created during the production process are fully recyclable.

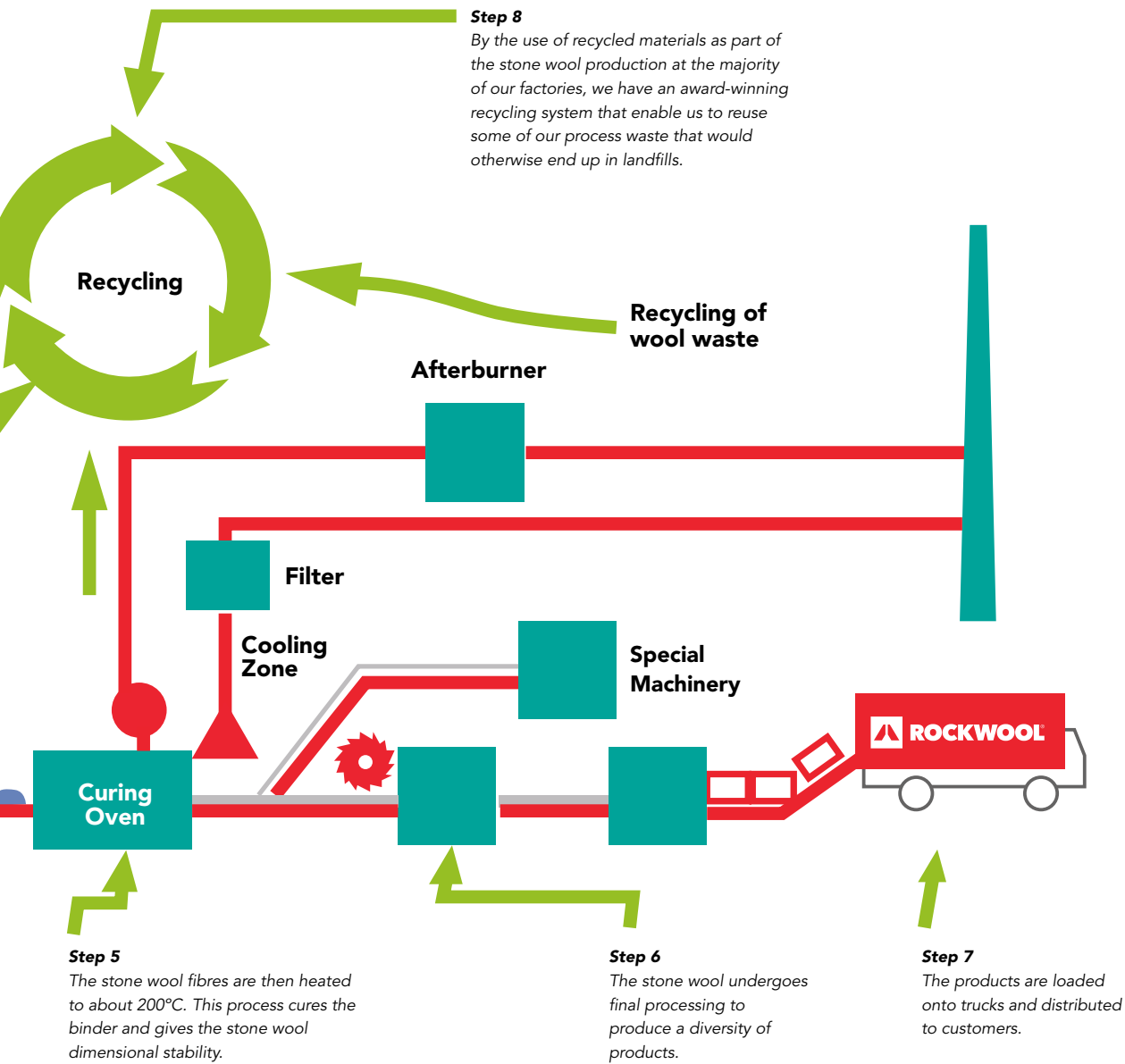

Application of ROCKWOOL Stone Wool Products

Single skin metal roof system

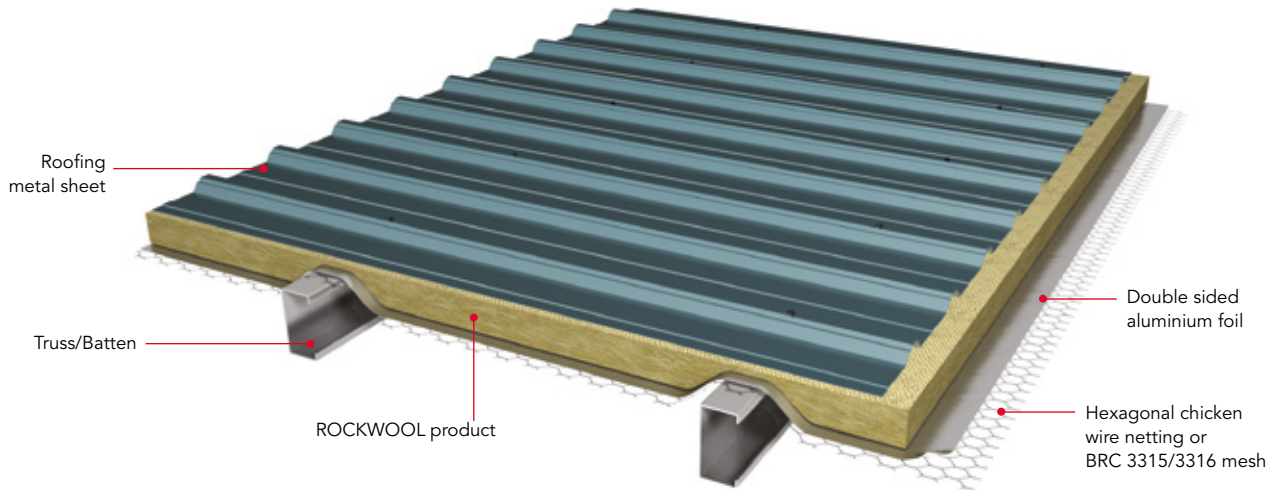

| Type of Application | ROCKWOOL Products | Types of Buiding | Key Performances |
|--|-----------------------|--------------------------|--|
| Single skin metal roof | Cool 'n' Comfort Roll | Residential & Industrial | <ul style="list-style-type: none"> ■ Thermal insulation ■ Condensation control ■ Rain / Noise reduction |
| Double skin metal roof | Cool 'n' Comfort Slab | Commercial & Industrial | <ul style="list-style-type: none"> ■ Noise reduction ■ Easy to install |
| Clay/concrete tile roof (between rafter) | Cool 'n' Comfort Roll | Residential | <ul style="list-style-type: none"> ■ Thermal insulation ■ Rain / noise reduction |
| Single-ply membrane flat roof | Hardrock | Industrial | <ul style="list-style-type: none"> ■ Non-combustible ■ Compression resistant ■ Dimensionally stable |

Double skin metal roof system

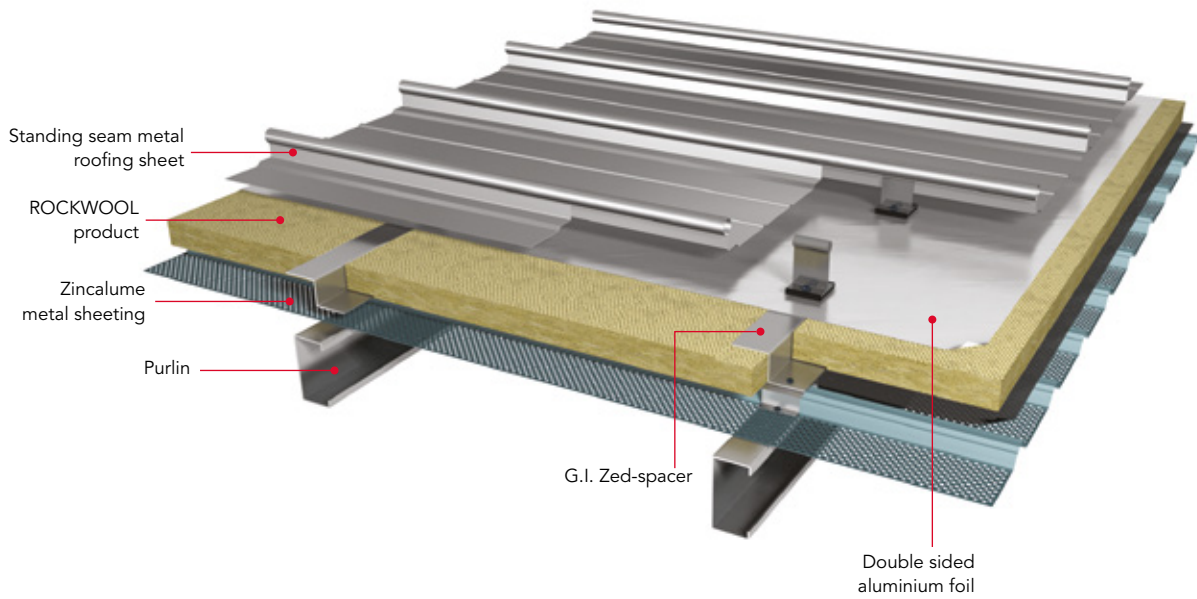

Application of ROCKWOOL Stone Wool Products

Internal drywall system

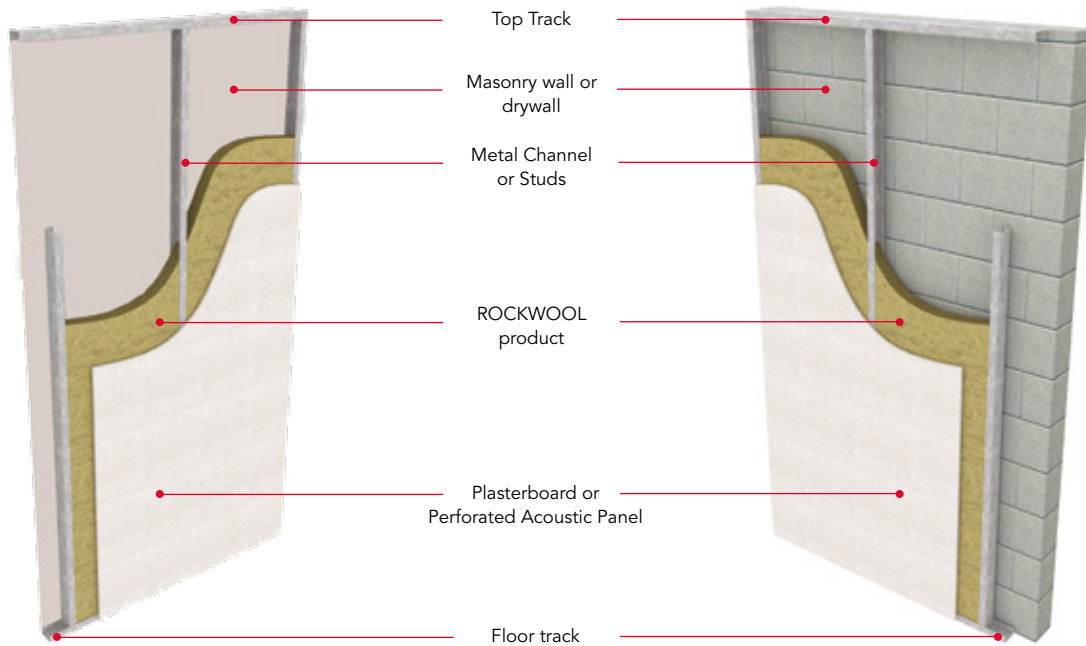

| Type of Application | ROCKWOOL Products | Types of Building | Key Performances |
|---------------------|--|---|--|
| Drywall partition | Safe 'n' Silent Pro330 Pro350 Pro370 | Residential Commercial Industrial | <ul style="list-style-type: none"> ■ Non-combustible ■ High melting point ■ Sag resistant |
| Drywall lining | Safe 'n' Silent Pro330 Pro350 Pro370 (black matte facing available) | Residential Commercial Industrial | <ul style="list-style-type: none"> ■ Noise reduction ■ Thermal insulation ■ Moisture resistant ■ Water repellent |

Ceiling system

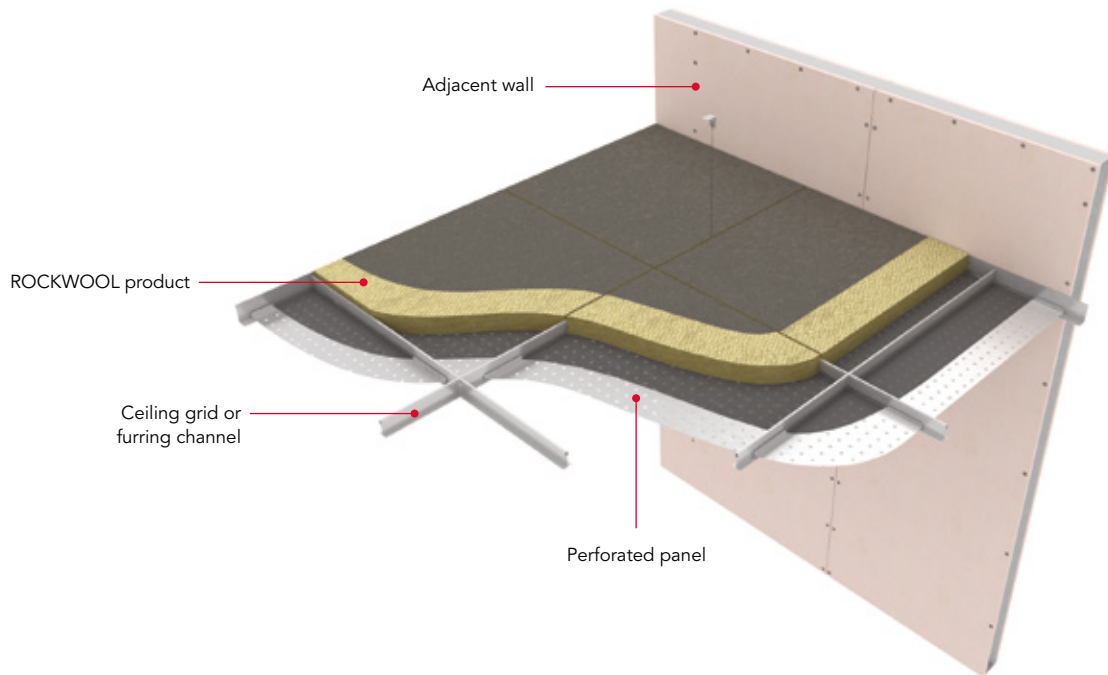

| Type of Application | ROCKWOOL Products | Types of Building | Key Performances |
|----------------------|--|---|--|
| Plasterboard ceiling | Safe 'n' Silent Pro330 Pro350 Pro370 | Residential Commercial Industrial | <ul style="list-style-type: none"> ■ Non-combustible ■ Thermal insulation ■ Energy saving |
| Perforated ceiling | Safe'n'Silent Pro330 Pro350 Pro370 (black matte facing available) | Residential Commercial | <ul style="list-style-type: none"> ■ Noise and echo reduction ■ Excellent noise absorption |

Application of ROCKWOOL Stone Wool Products

Single skin metal wall

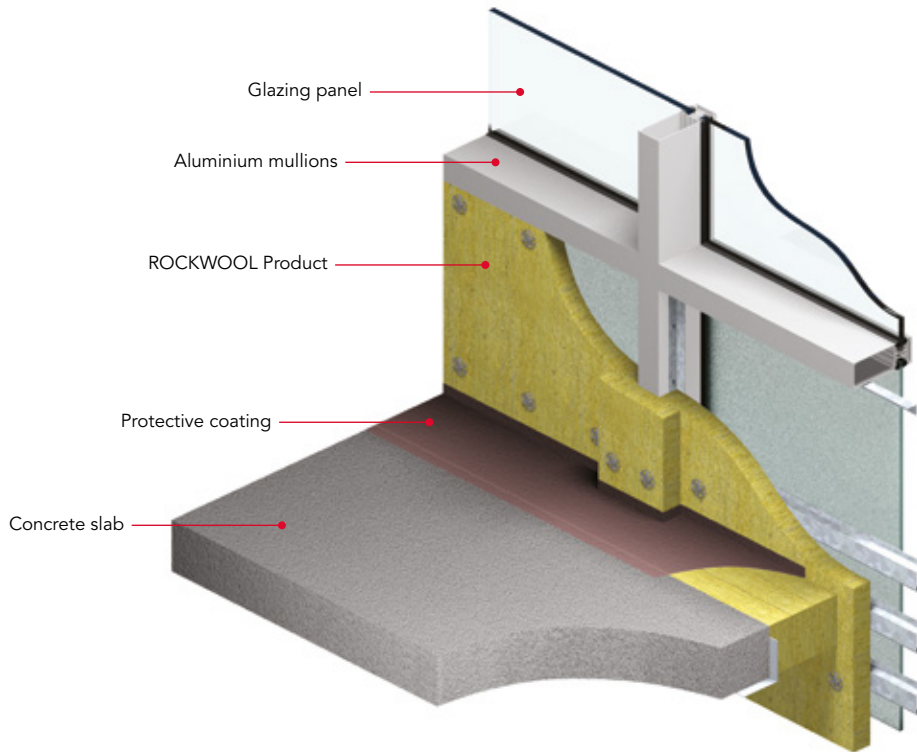

| Type of Application | ROCKWOOL Products | Types of Buiding | Key Performances |
|--------------------------|---------------------------------|------------------|---|
| Unitized curtain wall | Thermalrock S60 with foil-faced | Commercial | <ul style="list-style-type: none"> ■ Fire performance ■ Thermal insulation ■ Acoustic performace |
| Built-up metal wall | Thermalrock S60 | Industrial | <ul style="list-style-type: none"> ■ Thermal insulation ■ Sag resistant ■ Easy to install |
| Ventilated facade | Thermalrock S100 | Commercial | <ul style="list-style-type: none"> ■ Thermal insulation ■ Water repellent ■ Moisture resistant |
| Double brick cavity wall | Thermalrock S40 | Residential | <ul style="list-style-type: none"> ■ Thermal insulation ■ Sag resistant ■ Water repellent |



**ROXUL ROCKWOOL Technical
Insulation India Pvt. Ltd.**

Wing B-2, 2nd Floor, Unit No. 206
Boomerang, Near Chandivali Film Studio
Chandivali Farm Road, Andheri (E)
Mumbai 400072, Maharashtra, India
T (+91) 22 6715 7700
F (+91) 22 6715 7710

**Indonesia Representative Office
ROCKWOOL Malaysia Sdn Bhd**

Wisma Pondok Indah Tower 3
17th Floor, Jl. Sultan Iskandar Muda V
Jakarta 12310, Indonesia
T (+62) 21 2965 9071
F (+62) 21 2953 8998

ROCKWOOL Malaysia Sdn Bhd

Lot 4, Solok Waja 1
Bukit Raja Industrial Estate
41050 Klang, Selangor, Malaysia
T (+60) 3 3341 3444
F (+60) 3 3342 7290

**ROCKWOOL Building Materials
(Singapore) Pte. Ltd.**

No. 8, Tuas Avenue 2, Jurong Town
Singapore 639448
T (+65) 6861 4722
F (+65) 6862 3533

ROCKWOOL (Thailand) Limited

B.GRIMM Building 11th Floor
5 Soi Krungthepkreetha 4
Huamark, Bangkok
Bangkok 10240, Thailand
T (+66) 2731 7511-14
F (+66) 2731 7510

**Vietnam Representative Office
ROCKWOOL (Thailand) Limited**

9th Floor, TNR Tower,
180-192 Nguyen Cong Tru Street,
District 1, Ho Chi Minh City, Vietnam
T (+84) 8 6288 2009
F (+84) 8 6288 4691

900 108 - 06 / 19_V4 (EN)

Disclaimer: The information contained in this brochure is applicable for India, Malaysia, Singapore and Thailand and is believed to be correct at the date of publication and is subject to change after the date of printing. ROCKWOOL does not accept responsibility for the consequences of using any product in this brochure in any applications different from those described here.

